

笔记本电脑产品手册

Notebook Computer Product Manual

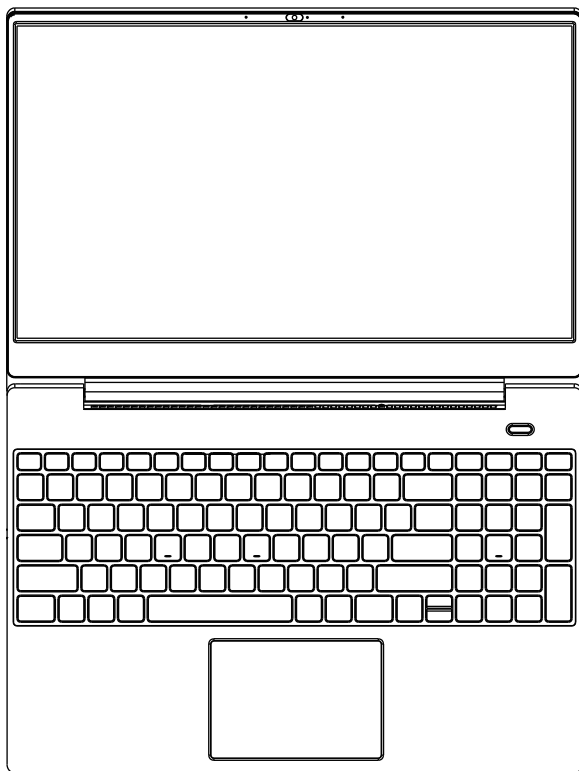

www.ipason.com

Ver: QYZS1.0

敬告

尊敬的用户：

感谢您的购买和使用攀升品牌笔记本电脑，为了您的安全和利益，在使用产品前，请您仔细阅读本产品说明书及随机附带的全部资料。如果您未按照产品说明书操作和使用产品，而导致任何的人身伤害，财产或其它损失，本公司将不承担责任。

关于本产品手册（以下简称“说明书”）

说明书版权属于本公司所有；

说明书提及的商标，字号属于它们各自的权利所有者；

说明书内容如同实际产品不一致，以实际产品为准。

如果您对说明书的任何内容或条款存在不明或异议，请在购机后七日内向本公司提出书面异议，否则视为您已经同意，理解并接受说明书全部内容。

产品使用过程中，如果您遇到问题，欢迎您登陆本公司网站www.ipason.com或拨打服务电话4000055360进行咨询。

本公司保留对说明书的解释和修改的权利。

致谢！

武汉攀升鼎承科技有限公司

责任申明

本说明书没有任何形式的担保，立场表达或其它暗示，若有任何因本说明书所提到的产品规格和资讯所引起的直接或间接的信息流失或事业终止，本公司及所属员工恕不为其承担任何责任。除此之外，本说明书所提到产品规格和资讯仅供参考，包括产品硬件和软件内容，其内容亦会随时更新，恕不另行通知。

目录

一、安全注意事项	1
警告及注意事项	1
安全指示	3
二、轻松入门	3
包装清单	3
笔记本电脑介绍	4
了解笔记本电脑	5
三、快速使用电脑	7
激活电池	7
使用电池	7
初始化电池	7
检查电池状态	8
正确打开方式	8
基本操作	9
触摸板使用	9
BIOS设置	9
四、产品中有害物质的名称及含量	10
五、服务与支持	11
保修服务条例	11
三包服务说明	11
概述	11
产品保修信息	12
售后服务流程	13
发回件注意事项	14
售后服务登记卡	14
维修记录	15

一、安全注意事项

警告及注意事项



警告：

不要在笔记本电脑上放置任何重物；
不要抓、扭或者撞击液晶屏幕表面。



警告：

为了预防火灾和电击的危险，请不要
把本产品的主部件暴露在雨水或潮湿
的空气里面。



警告：

不要在过冷、过热(35°C)、过于潮湿、
多尘的环境下长期使用，不要让本机在
阳光下曝晒。

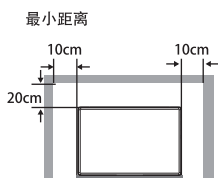

注意：

如果把本产品放进一个间隔或是相对拥挤的空间里，必须如左图一样保持最小的距离。过热会缩短本产品的寿命而且也会造成危险。



注意：

请勿随意拆卸。请勿将本机的电源适配器用于其它计算机，以避免电冲击、
燃烧或器件的损坏。





注意：

不要把本产品放在一个不牢靠的架子、搁板或是桌子边缘，因为如果它掉下来会严重伤害到个人，并会损坏产品本身。



注意：

在系统正在访问软驱、光驱、移动存储等介质时，请勿移除介质，否则可能会导致系统崩溃或数据损坏。



注意：

温度：-20℃—60℃（温度变化<10℃摄氏度/小时）湿度：10%—90%（无结露状况）当环境温度达到60℃时，环境湿度要在20%以下。



安全指示

- 本产品仅适用于 2000 米以下非热带地区。
- 使用干燥、柔软的布（不含挥发性物质）擦拭笔记本屏幕。
- 不要将笔记本电脑放置在不稳定，易跌落的地方。
- 避免本机跌落地面或受到其它强烈冲击。
- 尽量避免在强磁、强静电环境下使用。
- 一旦有水或其它液体泼洒到本机上，应立即关机，将本机擦拭、晾干后才可使用。
- 切勿使用任何含化学成份的清洁剂或其它液体擦拭本机，避免因腐蚀和受潮造成损坏，如确实有清洁必要，请用干燥的软布或纸巾擦拭。
- 本公司对人为非正常的软硬件操作、维修或其它意外情况导致的机内资料损失或删除不承担责任，也不承担因此而导致的其它损失。
- 请随时备份您的重要资料，以免丢失。
- 请不要自行拆卸本机，否则会丢失保修的权利。
- 如果您的笔记本电脑坏了，不要自己修理，请与专业维修人员联系。
- 用错误型号电池更换会有爆炸危险，务必使用原装电池。
- 本设备如果长期不使用，请拔掉电源插头。

二、轻松入门

包装清单内容

请小心拆除包装，取出机器和其他配件，如发现有损坏和遗漏，请立即联络经销商。请保存原有的包装材料，以备换货之需。

本公司笔记本电脑包装清单内容如下：

- | | |
|-------------|--------------|
| 1.笔记本电脑 X 1 | 2.产品手册 X 1 |
| 3.电源线 X 1 | 4.电源适配器 X 1 |
| 5.附件盒 X 1 | 6.CPE磨砂袋 X 1 |
| 7.充气袋 X 1 | |

笔记本电脑介绍

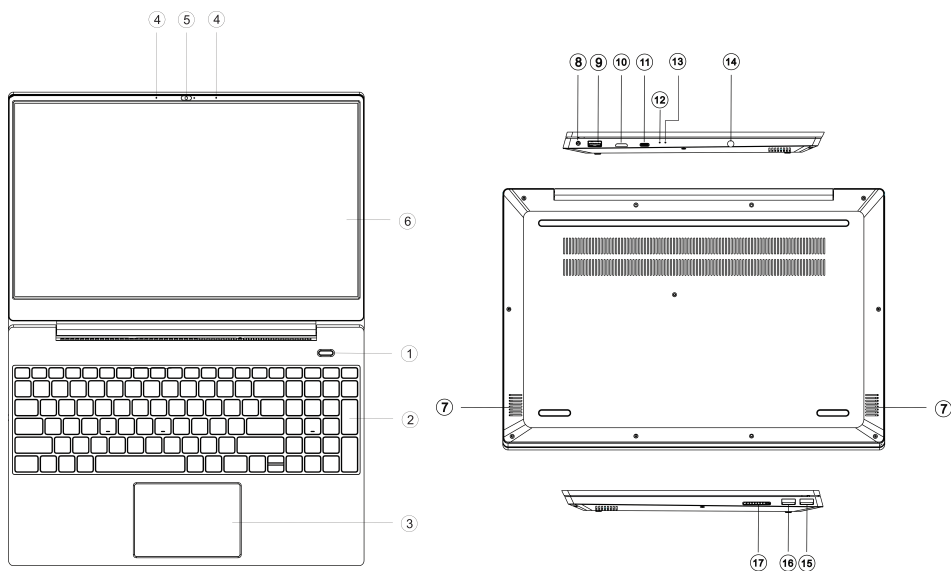

代号	名称	代号	名称	代号	名称
1	电源按钮	7	内置喇叭 * 2	13	充电指示灯
2	键盘	8	电源插孔	14	耳机插孔
3	触摸板	9	USB 3.0	15	USB 2.0
4	内置麦克风 * 2	10	Mini HDMI 接口	16	USB 3.0
5	摄像头	11	Type-C 接口	17	存储卡插槽
6	显示屏	12	电源指示灯		

了解笔记本电脑

电池状态指示灯

指示灯状态	充电状态	表示的含义
白色常亮	电池充满，未充电	电池充满
红色常亮	正在充电	正在充电
闪烁	正在放电	电量小于或等于 7%

将电脑停止

当您完成工作时，您可以将电脑电源关闭或者让电脑进入待机或者休眠模式

停止的模式	方法	再次开机或使用的方法
直接关闭电源	请遵照操作系统的关机程序,如此可以避免资料的流失或软件的损坏。 万一系统因为硬件或软件的问题而死机，则使用电源按钮关机	使用电源按钮
等待	根据您在Windows 的设定，以下述方式进入待机状态： A. 合上电脑上盖 B. 使用电源按钮	使用电源按钮

DC 电源接口

搭配19V/3.42A,DC电源适配器。

键盘功能

图示	功能键	功能实现	图示	功能键	功能实现
	Fn+F1	进入睡眠状态		Fn+F7	切换显示 LCD/HDMI
	Fn+F2	关闭喇叭音量		Fn+F8	开启/关闭 LCD 显示屏
	Fn+F3	降低喇叭音量		Fn+F9	开启/关闭飞行模式
	Fn+F4	调高喇叭音量		Fn+F10	开启/关闭触摸板
	Fn+F5	LCD 屏幕亮度减小		FN+ 空格	开启键盘背光灯软件
	Fn+F6	LCD 屏幕亮度增大			

三、快速使用电脑

激活电池

您随机所配的笔记本电池为高能锂离子电池，在第一次使用前请按如下方法操作激活电池：初次使用锂离子电池时，电池内可能只有很少的残余电量，需要先给电池充电。在关机状态下充电，充电时间要大于5小时；在开机状态下充电，充电时间要大于6小时。

注意：

- (1)在充电过程中请不要断开外接电源。
- (2)请勿随意使用非本机器专用的电池。

前三次使用时请将电池的电量全部使用完再进行充电。并且，充电时间不能低于首次充电的时间。以保证电池最大限度的被激活，保证电池的有效使用时间。上述过程称为激活电池。

使用电池

当您不使用外接电源时，电脑将自动切换到电池为整个系统供电。电池的具体使用时间会因不同的因素而改变，包括LCD亮度、系统电源管理特性、应用程序、外设使用状况、电池累计使用时间等因素。当电池电量使用一部分或用完之后，您可以将电源适配器接入笔记本电脑为电池充电。电池的充电状态通过笔记本电脑左侧的电池指示灯显示。

提示：无论电池是否装在电脑内，都会有自放电的现象（一天约1%）。所以请在每个月对电池进行一次完整的充放电。如果您的电脑长时间未使用，电池会由于长期自放电而产生电量损失甚至耗光，这是锂离子电池的固有特性所致，属正常现象。此时应使用外接电源供电。若使用外接电源仍无法开机（电池指示灯也不亮），表明电池已经进入自保护状态，这时请在关机状态下外接电源充电一段时间（2~4个小时）激活电池，使电池可以正常充电后，再开机使用。

电池初始化

笔记本电池经过长时间使用后，您逐渐会发现使用电池的实际放电时间会比原先的放电时间减少许多，这是锂离子电池的记忆效应造成的。您可以对电池进行初始化来去除记忆效应。初始化是指将电池充满电后，把电放尽，并再次充满的过程。请按照以下步骤来完成一次初始化：

请确定电脑处于关机状态，然后接上外接电源充电。

充满电之后再开机。按下[ESC]或[DEL]进入BIOS设置程序，并让电脑停在该处。

拔除电源适配器，让电脑持续开着，直到电池没电而关机为止。

接上电源适配器将电池充满。使用充满电的电池，将电量耗光。

以上步骤反复2—3次，即可消除部分记忆效应，延长电池的使用时间。

提示：由于锂离子电池有一定的使用寿命，当您可以使用外接电源时，尽量使用外接电源供电，减少电池的使用次数，可以有效的延长电池的使用寿命。

检查电池状态

当您使用电池供电时，采用以下方法可以获知电池的状态和剩余的电量：

鼠标左键单击Windows任务栏右下角的电池图标时，将显示电池指示器，通过指示电池中的剩余电量和计算机使用的电源计划可以帮助您管理计算机的电源消耗。

打开方式

为了达到最佳的显示效果，建议视线垂直与笔记本电脑中心部位进行观看，如需适当调节，请双手握住屏幕两侧适度调整，开盖最大角度135°。

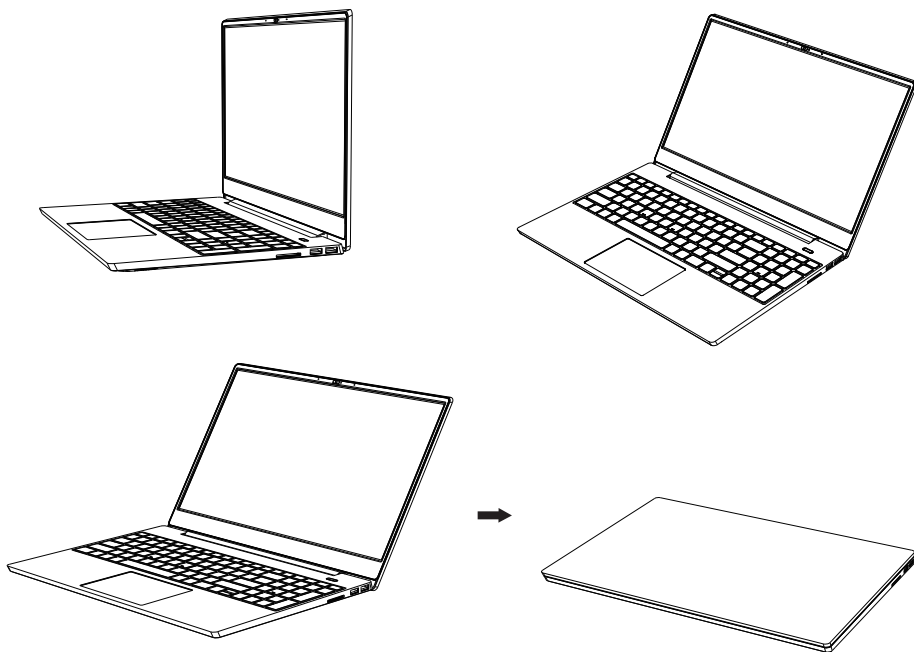

基本操作

开关机

- 在平整干净的桌面上放置好笔记本电脑。
- 去掉所有的包装。
- 将电源线连接到电源适配器上。
- 将电源适配器输出接头连接到笔记本的电源接口。
- 将电源线连接到输出电压在 100-240V 范围内的交流电源上。
- 第一次开机长按电源键两秒，看到电源指示灯亮起后松开按钮即可开机。

触摸板使用

1. 触摸板的使用特性：

触摸板上轻敲如同单击鼠标左键，轻敲通常比单击左键更方便。轻敲两次如同双击左键。

2. 不用按键而进行拖放：

您经常需要按住鼠标按键来移动光标(例如在屏幕中移动图标或视窗)。这个动作被称为拖放。当您使用触摸板时，您可不使用按键而进行拖放。

BIOS设置

开机到logo处按下[ESC]或[DEL]，进入BIOS设置界面。

四、产品中有害物质的名称及含量

部件名称	有害物质					
	铅(Pb)	汞(Hg)	镉(Cd)	六价铬(Cr6+)	多溴联苯(PBB)	多溴二苯醚(PBOE)
主机	×	○	○	○	○	○
适配器	×	○	○	○	○	○
电池	×	○	○	○	○	○
线缆	×	○	○	○	○	○

本表格依据SJ/T11364 的规定编制

○:表示该有害物质在该部件所有均质材料中的含量均在GB/T 26572 规定的限量要求以下。

×:表示该有害物质至少在该部件的某一均质材料中的含量超出GB/T 26572 规定的限量要求,且目前业界没有成熟的替代方案,符合欧盟 RoHS 指令环保要求。

根据型号的不同,可能不会含有以上的所有部件,请以实际购买机型为准。



此电子信息产品在说明书所述的使用条件下使用本产品,含有的有毒有害物质或元素不致发生外泄,从而对环境造成污染或对人身、财产造成严重损害的期限为10年。

《废弃电器电子产品回收处理管理条例》提示性说明

为了更好地关爱及保护地球,当用户不再需要此产品或产品寿命终止时,请遵守国家废弃电器电子产品回收处理相关法律法规,将其交给当地具有国家认可的回收处理资质的厂商进行回收处理。

五、服务与支持

保修服务条例

尊敬的用户：

为了更好地使用本产品，通过本产品随机附带的保修卡向您做出下述维修承诺，并按国家有关部门颁布的《微型计算机商品修理更换退货责任规定》（以下称“三包”）中的内容和范围，向您提供三包服务。若出现三包故障时，可凭该产品保修卡正本到该商品购买处（如经销商或代理商）进行申请办理维修服务。

本保修条款独立于您所购买产品适用的其他任何保修条款，但并不会以任何方式影响或限制国家法定的保修条款。

三包服务内容如下：

- 1、商品自售出之日起十五日内（凭有效的产品保修卡正本），出现三包中《微型计算机商品性能故障表》所列故障时，消费者可选择换货或修理。
- 2、商品自售出之日起一年内（凭有效的产品保修卡正本），出现三包中《微型计算机商品性能故障表》所列故障时，消费者可选择修理。

概述

- 1、自购机之日起的有效保修期内，于正常操作使用状况下，产品出现性能故障，可享受攀升免费售后维修服务。
- 2、在购机时，请向经销商索取有效购机发票，并妥善保管。有效购机发票要求：发票上须注明本产品的序列号、型号、销售日期、销售者印章以及销售金额等内容。请您保留有效购机发票原件和产品保修卡，于产品享受保修服务时出示。
- 3、当您提供产品对应的有效购机发票时，将以发票开具的日期开始计算。若无法提供有效购机发票和保修卡，则保修期将按产品机身序列号对应生产日期作为开始日期。
- 4、本产品的保修服务不包括由于不正确的安装、操作、清洁、维修、意外事故、损坏、误用、滥用、非攀升原厂零配件、软件错误、自然磨损或其它非控制范围之内的事件、行为、故障或疏忽所造成的故障。
- 5、本保修内容不包括随产品搭配的配件，例如电源线、电脑包、鼠标等。原厂预装操作系统、原厂附赠软件以及原厂附赠的赠品，遵照国家相关规定实施保修。非攀升原厂搭配销售的赠品，以活动规定保修方式进行保修。

- 6、代理商或经销商自行承诺的额外服务与附加的非原厂配件及非原厂赠品，由原代理商或经销商负责服务、保修及技术支持。
- 7、产品维修后，所有用户的原始数据可能将被永久删除。
- 8、攀升提供售后维修服务时，所有更换的主机、零件、配件等均归攀升公司所有。
- 9、为消费者用户提供的保修按三包规定执行。非属三包范围的保修，按攀升保修政策执行。

售后服务流程

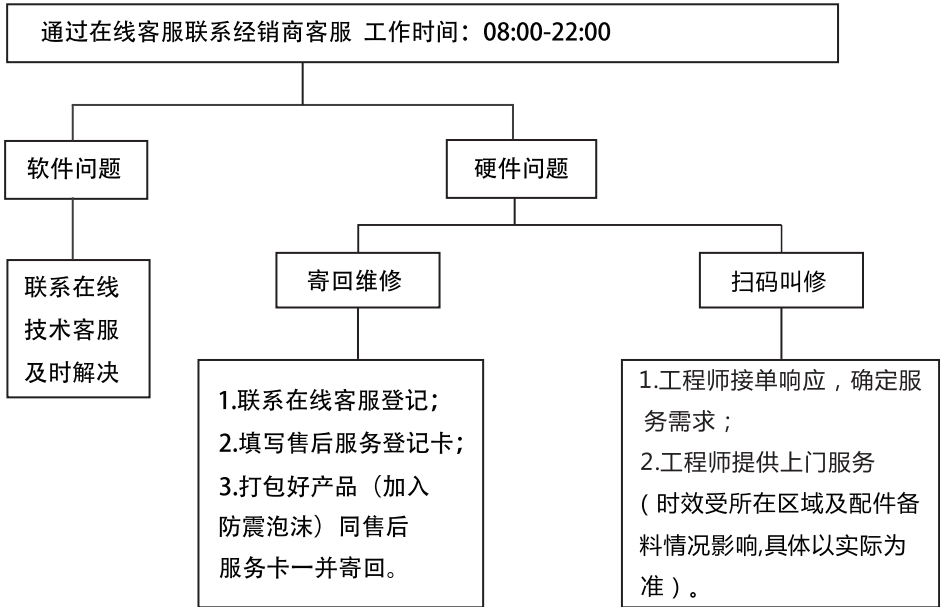

- 注：1. 服务期限自快递签收之日起，部分配件以厂家提供的保修期限为准。
2. 我司有权根据最新的售后服务政策调整上述服务内容。

发回件注意事项

- 为保证数据安全，请务必对您认为重要的数据自行备份。我司不提供备份及恢复数据的服务，也不承担相应的法律责任。
- 如发生退换货请您一定要将产品原包装一并退回，请勿在原包装上粘贴任何标签；（若原包装有问题，厂家将不予换新，只能做维修）
- 本店产品均为电子产品，请您注意做好包装防震工作，我们将不胜感激。

售后服务登记卡

尊敬的用户，真诚的感谢您购买攀升品牌产品！本产品保修卡是申请保修服务的重要凭证，请您配合销售商填写并妥善保管，谢谢！

ID用户名（必填）		订单编号（必填）	
您的姓名（必填）		联系电话（必填）	
售后原因（为了更快为您解决问题，请用正楷字体认真详细填写故障现象）			
您的收货地址:若您的联系人、联系方式、联系地址等信息有任何变动，请务必联系在线客服备注。无备注订单一律按订单默认信息处理。			

维修记录：

维修日期	维修单位名称	故障现象	故障处理情况	维修完成日期	维修人员签字



Warning

Dear Users:

Thank you for purchasing and using IPASON brand laptop. For your safety and benefit, before using the product, please read this product manual and all the information provided with it carefully. If you use the product without following the product instructions, the company will not be liable for any personal injury, property or other damage caused by the use of the product.

About this product manual (hereinafter referred to as "instructions")

The copy right of the manual belongs to the company;

Trademarks mentioned in the specification, the fonts belongs to their respective rights holders;

The contents of the manual are inconsistent with the actual products, which subject to the actual product.

If you have any questions or disagreements about any content or terms of the manual, please submit it to the company within 7 days after purchase.

If there are no written objections, you are deemed to have agreed to understand and accept the entire contents of the manual.

If you encounter any problems during the use of the product, welcome to visit our website www.ipason.com or call customer service 4000055360 for consultation

The company reserves the rights to interpret and modify the instructions.

Thank you!

Wuhan Ipason Technology Co., Ltd

Responsibility Statement

This manual does not contain any form of warranty, positional expression or other hints, if any are mentioned in this manual. If there are direct or indirect loss of information or business termination caused by product specifications and information, the company and its employees do not take any responsibility for it. In addition, the product specifications and information mentioned in this manual are for reference only, including product hardware and software contents. Its content will be updated at any time without notice.

Contents

I. Safety Precautions	16
Warnings and Precautions	16
Safety Instruction	18
II. General Instructions	18
Packing List	18
Computer Introduction	19
Getting Familiar with the Computer	20
III. Quickly Use the Computer	22
Activate Battery	22
Using Battery	22
Initialization of the Battery	23
Check Battery Status	23
Correct Way to Open	24
Basic Operations	24
Touchpad Usage	25
BIOS Settings	25

I. Safety Precautions

Warnings and precautions



Warning:

Do not place any heavy objects on your laptop;
Do not scratch, twist or hit the surface of the LCD screen.



Warning:

In order to prevent the risk from fire and electric shocks, please do not expose the main parts of this product to rain or moisture.



Warning:

Do not put in a place too cold, too hot (<math><35^{\circ}\text{C}</math>) or too humid.
Long-term use in a dusty environment, don't exposure the computer to the sun.

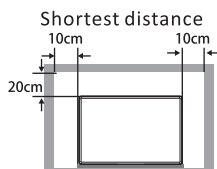

Warning:

If you put this product in a relatively crowded space, it must be kept at least at a distance as small as the left picture. Overheating will shorten the life of the computer and it can also be dangerous.



Note:

Do not randomly disassemble. Do not apply the adapter of the computer to other computers to avoid electrical shocks in case of burning or damage to the device.





Note:

Don't put this product on an unreliable shelf, a board or table edges because if it falls and will seriously harm individuals and damage the product itself.



Note:

When the system is accessing the floppy drive, CD-ROM drive, mobile storage, do not remove the media when storing media, otherwise can cause system crash or data corruption.



Note:

Temperature: -20 °C - 60 °C (temperature change < 10 °C / h) Humidity: 10% -90% (No condensation)
When the ambient temperature reaches 60 °C, the ambient humidity should below 20%.



Safety Instruction

- This product is only suitable for non-tropical areas below 2000 meters.
- Wipe the laptop screen with dry, soft cloth (no volatile substance).
- Do not put your laptop in an unstable, easy-to-drop place.
- Avoid dropping the unit or any other strong shock.
- Try to avoid using it in strong magnetic and strong static environment.
- Once water or other liquid is spilled on the unit, turn it off immediately, wipe the unit and dry it before use.
- Do not use any chemical-containing detergent or other liquid to wipe the unit to cause corrosion and moisture.
- If it is necessary to clean, please wipe with soft cloth or paper.
- The company is not responsible for the loss or deletion of in-flight data caused by abnormal human hardware and software operation, maintenance or other accidents, and does not bear other losses caused by these.
- Please back up your important information at any time to avoid loss.
- Please do not disassemble the computer yourself, otherwise the warranty will be ineffective.
- If your laptop is broken, do not repair it yourself, please contact with a professional service person.
- There is a danger of explosion if you replace it with the wrong types of battery. Always use the original battery.
- If the device is not used for a long time, please unplug the power cord.

II. General Instructions

Packaging List

Please carefully remove the package, get the machine and other accessories, if you find any damage or omission, please contact the dealer immediately.

Please keep the original packages in case you need to change them.

The contents of the company's laptop packaging list are as follows:

- | | |
|-----------------------|-----------------------|
| 1. Laptop x 1 | 2. Product Manual x 1 |
| 3. Power cord x 1 | 4. Power adapter x 1 |
| 5. Attachment Box x 1 | 6. CPE sand bag x 1 |
| 7. Air Bag x 1 | |

Computer Introduction

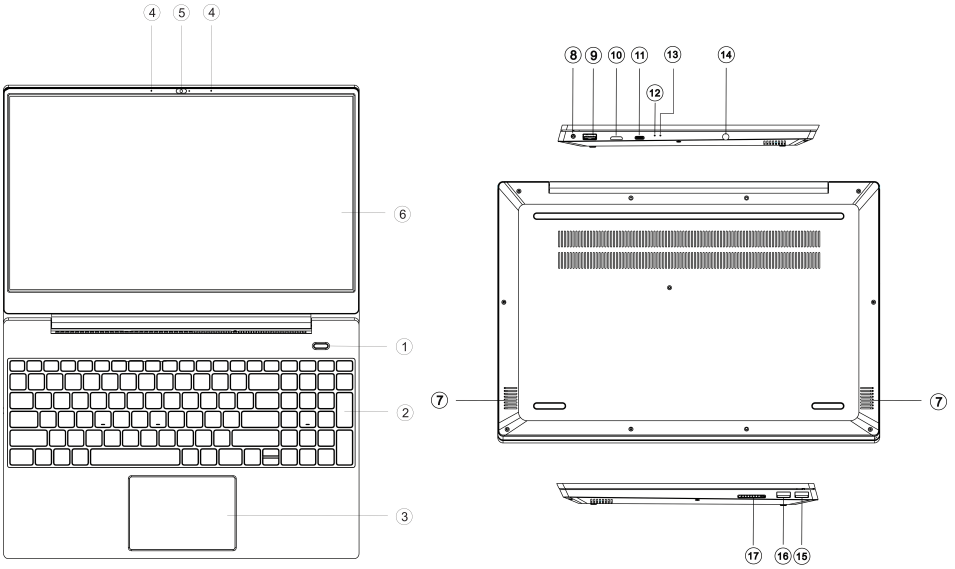

Item	Name	Item	Name	Item	Name
1	Power button	7	Speaker	13	Battery status indicator
2	Keyboard	8	AC power adapter jack	14	Earphone/Mic jack
3	Touchpad	9	USB 3.0	15	USB 2.0
4	Built -in microphone	10	M ini HDMI	16	USB 3.0
5	Camera	11	Type - C	17	Card reader
6	Computer display	12	Power status indicator		

Getting Familiar with the computer

Battery status

Battery status indicator	Charging status	Meaning
ON(Solid white)	Battery has fulfilled	The battery has fulfilled
ON(Solid red)	charging	The battery has charging
Blinking quickly(red)	Discharging	The battery has less than 7% charge

Stop the computer











When you finish your work, you can shut off the computer power or let the computer enter the mode of standby or hibernation.

Mode of stopping	method	Method on re-starting or usage
Directly shut off the power	Please follow the program for shutting the operating system.. By doing so, you can avoid the losses of data or damages of software. If the system is halted due to the problems on hardware or software , you can use the power button to shut off the computer.	Using the power button
Standby	According to your setup of Windows, the system will enter the standby status according to following method: A. Close the computer button; B. Use the power button.	Using the power button

DC Power Port

With 19V / 3.42 A, DC Power adapter.

Function of keyboard

Show	key combination on	function	Show	key combination on	function
	Fn+F1	Making the system the hibernation mode		Fn+F7	Repeatedly switch among the three image entry mode, LCD, HDMI, LCD+HDMI
	Fn+F2	Mute		Fn+F8	Shutting off or open the display screen
	Fn+F3	Decreasing the sound of speaker		Fn+F9	Flight mode on/off
	Fn+F4	Increasing the sound of speaker		Fn+F10	Shutting off the function of touch pad
	Fn+F5	Decreasing the brightness of LCD		FN+S pace	Turn on/off the keyboard backlight
	Fn+F6	Increasing the brightness of LCD			

III. Quickly Use the Computer

Activate the Battery

Your laptop battery is a high-energy lithium-ion battery. Please activate as follows before using it for the first time.

Battery: When using a lithium-ion battery for the first time, there may be only a little residual power in the battery. You need to charge the battery first.

Charging in the off state, the charging time should be longer than 5 hours; charging in the power-on state, the charging time should be longer than 6 hours.

Note:

- (1) Do not disconnect the external power supply during charging.
- (2) Do not use batteries that are not designed for this machine.

When using the first three times, please charge the battery before using it up. Also, the charging time cannot be shorter than the time of the first charging. In order to ensure the maximum activation of the battery, to ensure the effective use of the battery. The above process is called activating the battery process.

Using Battery

When you do not use an external power source, the computer will automatically switch to the battery to power for the entire system. The specific battery life will vary depending on factors such as LCD brightness, system power management features, application, peripheral usage, and battery life. When the battery is used partially or used up, you can connect the power adapter to the laptop to charge the battery. The battery's charge status is indicated by the battery indicator on the left side of the notebook.

Tip: No matter whether the battery is installed in the computer, there will be self-discharge (about 1% a day). So please perform a complete charge and discharge of the battery every month. If your computer has not been used for a long time, the battery will lose power or even consume light due to long-term self-discharge. This is due to the inherent characteristics of the lithium-ion battery, which is normal. In this case, you should use an external power supply. If the external power supply is still unable to be turned on (the battery indicator is not lit), it indicates that the battery has entered the self-protection state. In this case, please charge the external power supply for a period of time (2~4 hours) in the off state to activate the battery, so that the battery can be normal. After charging, turn it on again.

Initialization of the Battery

After a long period of use of the laptop battery, you will find that the actual discharge time of the battery is much less than the original discharge time, which is caused by the memory effect of the lithium-ion battery. You can initialize the battery to remove memory effects. Initialization refers to the process of charging the battery fully and dissipate power then fully recharge. Please follow the steps below to complete an initialization:

Make sure the computer is turned off and then plugged in with an external power.

Turn it on after it is fully charged. Press [ESC] or [DEL] to enter the BIOS setup and keep your computer in the state.

Unplug the power adapter and turn on the computer until the battery runs out.

Plug in the power adapter to fully charge the battery. Use the fully charged battery to dissipate the power. Repeating the above steps 2-3 times can eliminate some memory effects and prolong battery life.

Tip: Since the lithium-ion battery has a certain service life, when you can use the external power supply, try to use the external power supply to reduce the number of battery usage, which can effectively extend the battery life.

Check Battery Status

When you are using battery power, you can know the status of the battery and the remaining battery power by clicking the battery icon in the lower right corner of the Windows taskbar with the left mouse button. The battery indicator is displayed by indicating the remaining battery power and the computer. The power plan you use can help you manage your computer's power consumption.

Correct Way to Open

In order to achieve the best display effect, it is recommended that the line of sight be vertically viewed from the center of the laptop. For proper adjustment, hold both sides of the screen with both hands and adjust it to a maximum angle of 135°.

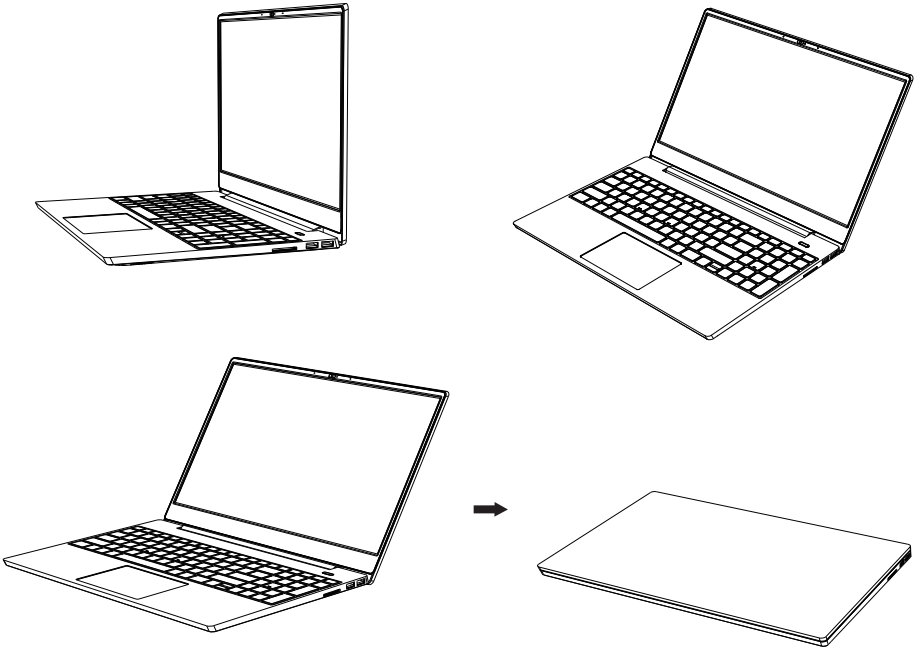

Basic Operations

Power ON/ OFF

- Place the laptop on a flat, clean desk.
- Remove all packaging.
- Connect the power cord to the power adapter.
- Connect the power adapter output connector to the computer's power connector.
- Connect the power cord to an AC power source with an output voltage in the range of 100-240V.
- After pressing the power button, release the button to boot it.

Touchpad Usage

1. Practical features of the touchpad:

Tapping on the touchpad is like clicking the left mouse button. Tapping is usually more convenient than clicking the left button. Tap twice as if you double-clicked the left button.

2. Drag and drop without pressing the button:

You often need to hold down the mouse button to move the cursor (for example, move an icon or window on the screen). This action is called drag. When you use the touchpad, you can drag and drop without using the buttons.

BIOS Settings

Boot to the logo and press [ESC] or [DEL] to enter the BIOS setup interface.

制 造 商：武汉攀升鼎承科技有限公司
地 址：武汉市黄陂区青武大道特1号攀升科技园
出 版 日 期：2020年07月
Manufacturer: Wuhan IpasonTechnology Co.,Ltd
Address : Ipason Technology Park, No.1 Qingwu
Avenue, Huangpi District, Wuhan City,
Hubei Province, China
Publication Date: 2020/ 07



IPASON
微信服务号
IPASON Wechat
www.ipason.com



3007-0886